

OPERATOR'S SAFETY AND SERVICE MANUAL

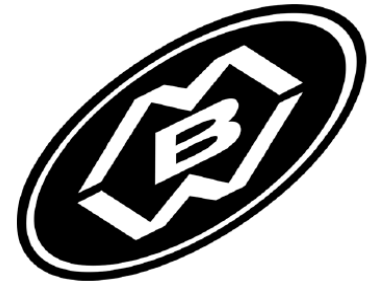

CE

F24 Trowel Machine



This manual covers the following
serial numbers for each model listed:
F24.....1740249-174999



<p>MBW, Inc. 250 Hartford Rd · PO Box 440 Slinger, WI 53086-0440 Phone: (262) 644-5234 Fax: (262) 644-5169 E-mail: mbw@mbw.com Website: www.mbw.com</p>	<p>MBW (UK) Ltd. Units 2 & 3 Cochrane Street Bolton BL3 6BN, England Phone: 01204 387784 Fax: 01204 387797</p>	<p>L18432 / 07.21.H © MBW, Inc. 2021 Printed in the USA</p>
--	---	---

Table of Contents

INTRODUCTION	4
EC DECLARATION OF CONFORMITY	5
1 GENERAL INFORMATION	6
1.1 GLOBAL ASPECTS ABOUT SAFETY	7
1.2 SAFETY SIGNS (PICTOGRAMS ON THE MACHINE)	8
1.3 SYMBOLS AND GLOSSARY	9
1.4 SPARE PARTS ORDER	10
1.5 REVISION OF THE MANUAL	10
1.6 GENERAL WARRANTY CONDITIONS	11
2 MACHINE CHARACTERISTICS	12
2.1 IDENTIFICATION DATA OF THE MACHINE	13
2.2 INTENDED USE	13
2.3 PROHIBITED USE	13
2.4 TECHNICAL AND DIMENSIONAL FEATURES / NOISE / VIBRATION / NON-IONIZING RADIATION 14	
2.5 OPERATOR POSITIONS/LAY-OUT/USE AND MAINTENANCE AREA/	15
2.6 GENERAL DESCRIPTION	15
2.7 TYPES OF POWER SUPPLY	16
2.8 SAFETY MEASURES	16
2.9 INFORMATION ON RESIDUAL RISKS	16
3 TRANSPORT AND LIFTING	22
3.1 PACKING AND UNPACKING	23
3.2 LIFTING AND HANDLING	23
3.3 TRANSPORT	24
3.4 STORAGE	24
3.5 DAMAGE CONTROL	25
4 MACHINE INSTALLATION	26
4.1 INSTALLATION	27
4.2 INITIAL TESTS	27
4.3 GENERAL SAFETY INSTRUCTIONS	28
4.4 STARTING THE WORKING CYCLE	28
4.5 TROWEL DRIVE	29
4.6 TROWEL MACHINE STOP	29
4.7 RESTARTING THE TROWEL	29
5 USE OF THE TROWEL MACHINE	30
5.1 SURFACE PREPARATION	31
5.2 TROWELING PHASE	31
5.3 FINISHING PHASE	31
6 MAINTENANCE AND REPAIRS	32
6.1 SCHEDULED MAINTENANCE	33
6.2 ROUTINE AND ADDITIONAL MAINTENANCE	37
6.2.1 <i>Blades replacement</i>	37
6.2.2 <i>Unlocking of blades holding arms and pressure plate</i>	37
6.2.3 <i>Trowel disc replacement</i>	37
6.2.4 <i>Replacing the belt</i>	38
6.2.5 <i>Refill of engine oil</i>	38
6.2.6 <i>Gear motor oil topping off</i>	39
6.2.7 <i>Notes about dismaltng</i>	39
6.3 TROUBLESHOOTING	40
6.4 PARTS LIST	42

MBW, Incorporated (MBW) thanks you for purchasing one of its products and invites you to read this manual.
This manual includes instructions for use, maintenance and spare parts list for the MOSKITO trowel machine.

Inside you will find all the information necessary for correct use of trowel machine purchased; therefore, the user must carefully follow the warnings contained in it and read it in every part to better understand the machine and avoid incurring problems caused by improper use.

According to the accident prevention regulations, the operators must be equipped with all the individual protection devices (P.P.E.) necessary to guarantee their own safety (safety shoes, safety helmet, gloves, ear protectors, etc.).

Please keep the manual in a suitable place to keep it intact.

The contents of this manual may be changed without notice or further obligation in order to include changes and improvements to the units already sent.
It is forbidden any reproduction or translation of any part of this manual without prior written notice and authorization by **MBW**.

No part of this publication may be reproduced, stored in a system or transmitted to third parties in any form or by any means, without prior written authorization by the Manufacturer.

INTRODUCTION



Operation and maintenance manual is an integral part of the machine: it is necessary to keep it intact and in a safe place during the whole life of the same, even in case of transfer to another user.

The MACHINE must be used in accordance with what specified in this manual: it is therefore recommended to read it carefully before operating it, not to mention nothing written and paying particular attention to messages in the boxes.

This manual has been produced with reference to the provisions of the Machinery Directive 2006/42 / EC as amended, with the aim of providing the user with general

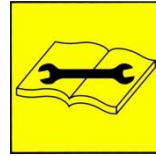

knowledge of the machine and with information for:

- Proper awareness of SAFETY issues.
- The intended use of the MACHINE, the characteristics of the user and the residual risks.
- The handling, installation, use and maintenance of the machine safely.
- The demolition of the machine and its disposal in safe conditions and in compliance with the regulations in force to protect the health of workers and the environment.

Compliance with the rules and recommendations contained in the manual provide safe and appropriate intervention.

EC DECLARATION OF CONFORMITY
(Directive 2006/42/EC-Annex IIA)
(written in the original language)

Name and address of the manufacturer of the machine:

BARIKELL S.r.l.

Via Razzaboni, 118 41122 Modena (Italy) – Tel. +39 059 31.11.78 – email info@barikell.it

Name and address of the company authorized to the draft of technical file: **SEMPREANORMA S.r.l.**

Via Turrini, 17 40012 Calderara di Reno Bologna (Italy) – Tel:+39 051.75.52.05
in the person of Pasquale Posa

We hereby declare that the machine: Trowel Moskito 60

Serial number:

Year Built: **2018**

Briefly described below:

The troweling machine, equipped with a rotating free wheel, allows the finishing of the edges on concrete floors, resin floors and substrates

it complies with directive 2006/42 / EC, directive 2014/30 / EU (electromagnetic compatibility) and 2014/35 / EU (low voltage) and the legislative provisions that transpose them

It is also compliant with the following harmonised standards:

- **UNI EN 12100:2010;**
- **UNI EN ISO 13849-1:2016;**
- **CEI EN 60204-1:2016;**
- **ISO 13105-2:2014.**

Modena,

In witness thereof

Luca Zivieri

(Legal representative Barikell S.r.l.)

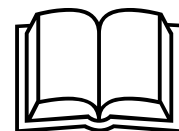

CHAPTER **1**

- 1 GENERAL INFORMATION**
 - 1.1 Global aspects about safety**
 - 1.2 Safety signs**
 - 1.3 Symbols and glossary**
 - 1.4 Revision of the manual**
 - 1.5 Spare parts order**
 - 1.6 General warranty conditions**

1.1 GLOBAL ASPECTS ABOUT SAFETY

Compliance with the rules and recommendations contained in this publication allows safe use of the machine and appropriate action.



- 1) The best performance and maximum life of the machine will be obtained from the proper use of the same. It is, therefore, necessary to scrupulously observe the instructions contained in this booklet;
- 2) Any requests for spare parts must be accompanied by the type of model and serial number reported in the spare parts list or applied on the number plates of the components themselves;
- 3) The machine installation must be carried out in compliance with the safety regulations in force;
- 4) Do not remove or tamper with the protections and safety devices, check periodically their effectiveness;
- 5) Strictly adhere to the warnings recalled on the danger postings (pictograms) and keep the message readable;
- 6) Operation and maintenance must be performed by qualified personnel, trained and authorized to the tasks foreseen. Intervention procedures and responsibilities of operators must be clearly defined to ensure safe and proper use and maintenance;
- 7) Before any maintenance or adjustment work, all the power supplies must be disconnected and locked, ensuring that they are not subject to unintentional start-ups;
- 8) The maintenance of the machine carried out in a manner that does not comply with the instructions provided, with non-original spare parts or without written authorization

by the company that performed the maintenance of the used machine or in any case in such a way as to jeopardize its integrity or modify its characteristics, exempts the company itself from any liability concerning the safety of persons and the faulty operation of the machine.

- **The user shall be required to respect warning about periodic maintenance indicated in Chapter 6;**
- **The user shall be required to respect the qualifications of the operating personnel:**

OPERATOR / MAINTENANCE



TECHNICIAN: Performs the tasks necessary for the basic operation of the machine: execution of the work cycle, implementation of operator commands, other interventions strictly related to normal production, possible daily cleaning and inspection, execution of ordinary maintenance operations (CFR. CHAP. 6). Strictly operates with safety devices enabled.

MAINTENANCE TECHNICIAN SPECIALIST (RESELLER)



Involved in all the operating conditions and levels of protection. Performs extraordinary interventions that cannot be run by the user (See CHAP. 6 about maintenance).

1.2 SAFETY SIGNS (PICTOGRAMS ON THE MACHINE)

It is absolutely necessary to recognize the meaning of the indications present on the machine and keep their message readable.

In case of damage replace them immediately. The following safety signs (pictograms) are installed. Residual risks are summarized in Chapter 2 PAR. 2.7.

WARNING SIGN GENERAL "MANUAL READING OBLIGATION"
INDICATION SIGNAL "USE LIFTING HOOK"
INDICATION SIGNAL "FIX THE LOAD TO TRANSPORT MEANS" (if applicable)
WARNING SIGN "DANGER of MOVING PARTS"
WARNING SIGN "DANGER of HIGH TEMPERATURES"
OBLIGATION SIGNAL "OBLIGATION TO USE EAR PROTECTORS"
OBLIGATION SIGNAL "OBLIGATION TO USE SAFETY SHOES"

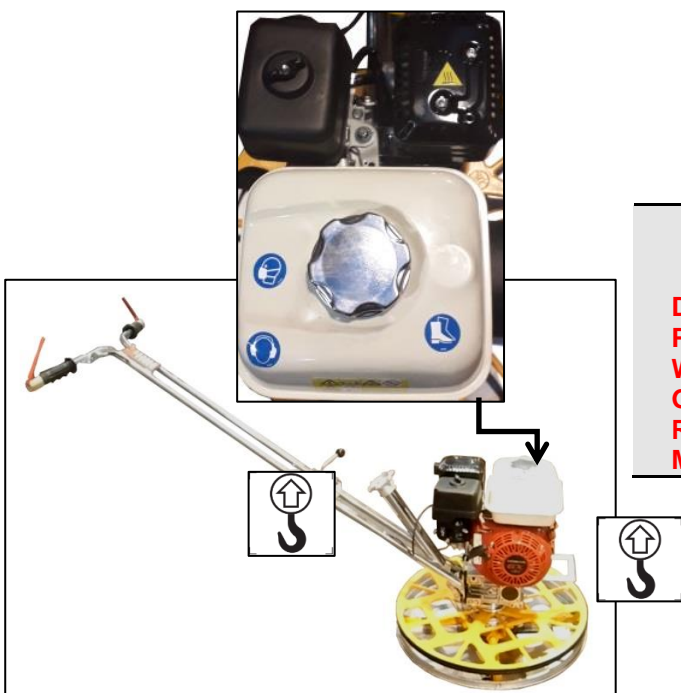
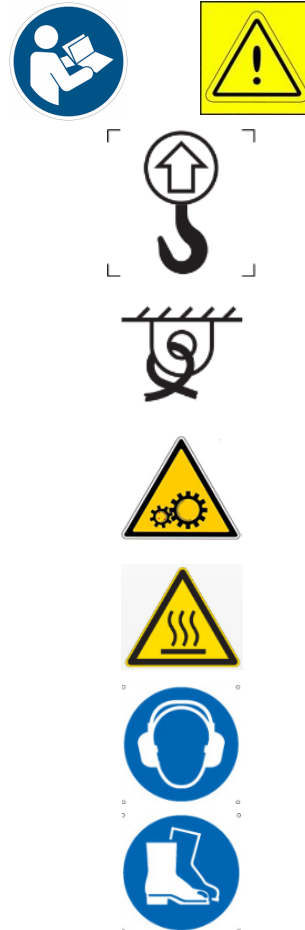

!WARNING!
DO NOT REMOVE, DAMAGE OR MODIFY THE PICTOGRAMS ON THE MACHINE. BEFORE EACH WORK SHIFT CHECK THEIR PRESENCE AND THE GOOD STATE OF PRESERVATION. IF DAMAGED, REPLACE THEM, PREVENTING THE USE OF THE MACHINE UNTIL REPLACEMENT.

1.3 SYMBOLS AND GLOSSARY

- **DANGER:** a potential source of injury or damage to health;
- **HAZARDOUS AREA:** any area inside and/or near the machine in which the presence of a person constitutes a risk to safety and health of that person;
- **EXPOSED PERSON:** any person wholly or partially in an hazardous area;
- **OPERATOR:** the person or persons given the task of installing, operating, adjusting, cleaning, repairing, moving or performing maintenance on the machinery;
- **RISK:** combination of the probability and severity of an injury or damage to health that can arise in a hazardous situation;
- **INTENDED USE:** the use of the machine in accordance with the information provided in the operating instructions (para. 2.2);
- **REASONABLY FORESEEABLE MISUSE:** the use of the machine in a way other than that indicated in the instructions for use, but which may result from readily predictable human behavior;
- **HUMAN-MACHINE INTERACTION:** any situation in which an operator interacts with the machine in any of the operational phases and at any time of life of the machine itself;
- **OPERATOR QUALIFICATION:** minimum level of competences the operator must possess to perform the operation described;
- **NUMBER of OPERATORS:** number of operators needed to carry out in the best way the operation described and resulting from a careful analysis carried out by 'Manufacturer', whereby the use of a different number of employees might prevent from getting the expected outcome or impair the safety of the personnel involved;
- **MACHINE STATUS,** means:
 - the mode of operation: automatic gear, manual operation, shutdown.
 - the condition of the safety devices on the machine: guards included, guards excluded, emergency stop pressed, type of sectioning of energy sources, etc .;
- **GUARD:** part of the machinery used specifically to provide protection by a material barrier;
- **SAFE STOP:** stopping condition obtained through security measures that avoid unexpected start of hazardous bodies;
- **RESIDUAL RISK:** risk that it was not possible to eliminate or reduce sufficiently through the design, against which the protections are not (or not totally) effective.
- The manual gives the information of its existence and instructions/warnings to overcome it;
- **SAFETY COMPONENT:** means a component used for ensuring a safety function and whose breakdown or malfunction affects the safety and/or health of exposed persons (eg. lifting device; fixed, mobile, adjustable guard, etc., electrical, electronic, optical, pneumatic, hydraulic, interlocking of a guard, etc.).
- **ABBREVIATIONS:**
 - CHAP. = Chapter
 - PAR = Paragraph
 - P. = Page
 - FIG. = Figure
 - TAB = Table
 - PPE = Personal protective equipment
 - CFR = Compare

Symbols are used in this publication with the following meaning:

! IMPORTANT: Indicates important technical information which must not be overlooked.



!WARNING: Indicates that it is necessary to adopt appropriate behaviours not to put at risk the health and safety of persons and not to cause economic damage.

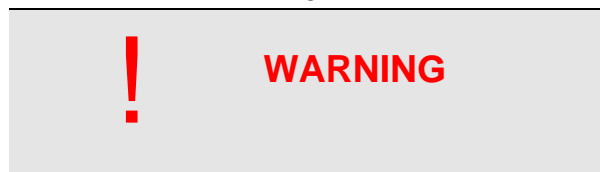

Generic warning sign that defines the obligation to read the manual:

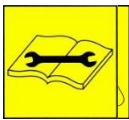

1.4 SPARE PARTS ORDER

The order of spare parts should clearly report the data needed for their identification and the data shown on the machine identification plate.

REVISION n.	DATE	AFFECTED PAGES	SIGNATURE EDITOR INSTRUCTIONS	NOTES	VALIDATION FOR ACKNOWLEDGEMENT OF THE MANUFACTURER
01	10/2018	ALL	<i>Spin automations</i>	–	

For further information we suggest contacting the manufacturer.

Ex.:

- Machine model
- Type
- Serial number
- Year of build
- Description
- Requested quantity
- Method of delivery
- Address, telephone number and name of the applicant

1.5 REVISION OF THE MANUAL

We recommend keeping this manual constantly updated, integrating it with the comments received by the maintainer. It is appropriate that any annotations or comments are inserted in a clear way.

Any amendments, additions or modifications must be documented using the form shown on the next page. The update must be performed on all copies.

The 1st revision of release of the manual is validated by the manufacturer who takes note of it and adopts the instructions contained therein. See the table below.

1.6 GENERAL WARRANTY CONDITIONS

The new machines covered by warranty with regard to the structure and use of suitable materials, subject to the following conditions:

- 1) Warranty is valid for a period of twelve (12) months.
- 2) The manufacturer undertakes to repair or replace at its discretion any parts or groups which have proved to be defective.
- 3) Repaired or replaced parts are covered under the same warranty as the original parts, expiring 12 months after the implementation of the parts themselves.
- 4) For completion of the work required and for delivery of spare parts the manufacturer reserves adequate time.
- 5) All transport costs of the parts intended for replacement covered by this warranty will be borne by the purchaser.
- 6) Repairs and interventions carried out during the warranty period by unauthorized personnel will void any right to warranty.
- 7) During the warranty period the replaced parts become the property of the manufacturer.
- 8) For the components not produced by us, the warranty conditions of the original suppliers apply. Any claims will be transferred to the buyer.
- 9) This warranty is valid and applicable only to the original purchaser. -
The warranty is void if the following situations happen:
 - a) The original owner transfers ownership of the machine,
 - b) If any changes have been made to the machine,
 - c) If parts and accessories not manufactured by us on have been added on the machine.
- 10) No responsibility is assumed for any damage caused to the floor by malfunctioning or stopping of the trowel machine during the processing phases.
- 11) The warranty does not include damage deriving from excessive stress, such as, for example, the continuation of the machine's operation after the detection of an anomaly

due to improper use or maintenance, the use of inappropriate operating materials as well as the non-observance of the Instructions for Use. The same applies to damages caused by normal wear and tear.

- 12) The manufacturer assumes no liability arising out of any difficulties related to resale or use abroad of the machine due to the application of provisions of the law relating to the protection of industrial property in force in the country where the machine is sold.
- 13) With regard to the engine warranty, the conditions of the original suppliers apply.
- 14) Established warranty conditions are binding for all sellers of MBW. Any different agreements will be considered valid only upon confirmation in writing by MBW.
- 15) Labor and processes necessary for the replacement of defective parts under warranty are charged to the Customer.

IMPORTANT!

Should it be necessary to use the warranty, please provide the following information:

- **Model and serial number of both the machine and the engine**
- **Date of purchase**
- **Detailed description of the problem.**

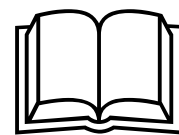

CHAPTER **2**

2 MACHINE CHARACTERISTICS

2.1 Identification data of the machine

2.2 Intended use

2.3 Use prohibited

2.4 Technical and dimensional features/noise/vibration/non-ionizing radiation

2.5 Layout/operation and maintenance area/operator position

2.6 General description

2.7 Types of power supply

2.8 Safety measures

2.9 Information on residual risks



WARNING

Do not remove, damage or modify the machine identification data present on it. In the event that data become unreadable immediately contact the manufacturer.

2.1 IDENTIFICATION DATA OF THE MACHINE

In order to ensure proper identification of the machine, please refer to the serial number stamped on the invoice and the data imprinted on the manufacturer's plate bearing the CE marking symbol attesting to its conformity to the applicable directives.

The plate has the following required content:



2.2 INTENDED USE

The trowel machine "Moskito" is meant to perform finishing of edges of concrete floor, resin flooring and/or substrates. To make this process the machine is equipped with a 4 or 6 blades rotor depending on the version, powered by an internal combustion engine. The fuel used is unleaded petrol, which comes from the tank to the carburettor after being filtered. Only one operator is required to operate the machine.

He should be able to move freely and unhindered.

This version of trowel machine (equipped with internal combustion engines) can be used exclusively outdoors and finishing work flush with the wall.

The machine may only be used by professional operators.

2.3 PROHIBITED USE

Any use other than as expressly set forth in paragraph (§ 2.2) and implemented in different ways or contrary to what is stated in this publication sets up the possibility of **misuse**. The manufacturer declines all responsibility resulting from improper use which can cause personal injury and for any malfunction of the system.

THE FOLLOWING PROHIBITED ACTIVITIES CONFIG. MISUSE:

- USE the MACHINE IN EXPLOSIVE ENVIRONMENT (THE ABOVE FACILITY IS NOT IN COMPLIANCE WITH ATEX 2014/34/EU).
- INTEGRATE WITH OTHER SYSTEMS AND/OR EQUIPMENT NOT CONSIDERED BY THE MANUFACTURER IN THE FINAL DESIGN.
- CONNECT THE MACHINE TO POWER SOURCE OTHER THAN THOSE SPECIFIED BY THE MANUFACTURER.
- USE THE MACHINE FOR A PURPOSE DIFFERENT FROM THAT EXPECTED AND SHOWN IN THIS PUBLICATION.
- USE THE MACHINE INDOORS.
- USE THE MACHINE NOT FLUSH WITH THE WALL.
- INFRINGE THE MAINTENANCE RULES DESCRIBED IN THIS PUBLICATION.
- USE THE MACHINE IN AIR CONTAINING SMOKE, DUST, WATER VAPOUR OR SOLVENTS.



- Manufacturer's name & address (1)
- CE marking (2)
- Build year (3)
- Type designation (4)
- Serial number (5)
- Engine serial number (6)
- Power of the engine (7)
- Mass in kg (8)

- USE DIFFERENT EQUIPMENT THAN THOSE EXPRESSLY DESIGNATED BY THE MANUFACTURER.
- LET THE MACHINE TO BE OPERATED BY A NUMBER OF OPERATORS DIFFERENT FROM THAT EXPRESSLY PROVIDED BY THE

MANUFACTURER (see PAR. 2.5 of this publication) OR DISOBEY THE DIRECTIONS REGARDING OPERATOR POSITIONING.

2.4 TECHNICAL AND DIMENSIONAL FEATURES / NOISE / VIBRATION / NON-IONIZING RADIATION

DESCRIPTION	Measurement Unit	Code 3005	Code 3012	Code 3021	Code 3028
Size:	[mm]	600x1506x100 0	600x1506x100 0	600x1506x100 0	600x1506x100 0
Packing size	[mm]	650x910x 800	650x910x 800	650x910x 800	650x910x 800
Operating weight	[kg]	61	62	63	64
Shipping weight	[kg]	78.5	79.5	80.5	81.5
Engine:	-	HondaGX160	Robin EX 17	GX160	Robin EX 17
Installed power:	[w/HP]	4 (5.5)	4.2 (6)	4 (5.5)	4.2 (6)
Starting:	[Type]	Manual	Manual	Manual	Manual
Cooling:	-	Air	Air	Air	Air
Power supply:	-	Gasoline	Unleaded Gasoline	Unleaded Gasoline	Unleaded Gasoline
Gasoline tank capacity:	[Lt]	2.8	3.2	3.2	3.2
Disc diameter	mm	600	600	600	600
Number of blades	Nr	4	4	6	6
Gearbox lubricant	Type	SYNTHETIC OIL FOR LONG LIFE REDUCERS ISO VG320 GRADING .	SYNTHETIC OIL FOR LONG LIFE REDUCERS ISO VG320 GRADING .	SYNTHETIC OIL FOR LONG LIFE REDUCERS ISO VG320 GRADING .	SYNTHETIC OIL FOR LONG LIFE REDUCERS ISO VG320 GRADING .
Number of drive shaft revolutions	r/min.	3600	3600	3600	3600

NON-IONIZING RADIATION

The MACHINE does not emit non-ionizing radiation dangerous for the operators.

NOISE AND VIBRATION

Residual noise values for machine in work

Sound pressure Level LpA	dbA	79,4
Sound power Level LwA	dbA	95,5

Values of vibration for working machine

Left handle value- increased exposure	A _{hv sum} [m/s ²]	< 2,5
---------------------------------------	---	-------

2.5 OPERATOR POSITIONS/LAY-OUT/USE AND MAINTENANCE AREA/

1st level OPERATOR POSITION



A single operator must work with the machine.

He drives the machine by acting on the handlebar to move it according to the needs of the processing and performs some ordinary maintenance activities.



ATTENTION

Only one operator is required to drive the machine.

Tasks and positions are detailed in para (§) 2.5 of this publication. Failure to follow the indications above conFIG.s the hypothesis of misuse and releases the manufacturer from any liability arising from misuse/abuse.

During use the operator position is adjacent to the handlebar of the machine.

The operator position is also considered an inspection position from which it is possible to oversee the smooth running of the working cycle.

The first level operator is also responsible for carrying out cleaning operations at the end of use.

2nd level OPERATOR (RETAILER-SPECIALIZED WORKSHOP)



The retailer (expert maintenance technician) performs maintenance and repair tasks provided by the manufacturer (compare Chapter 6 of this publication).

Always intervenes when the machine is stopped and energy cut.

IMPORTANT!

To define use and maintenance you need to about 1.5 m on all sides of the machine (fig 2.3 on next page).

2.6 GENERAL DESCRIPTION

The Trowel "Moskito" is dedicated to finishing of the edges on concrete floors, resin floors and substrates. Operation is manual.

The power supply is supplied by a an unleaded gasoline fuelled engine.

FUNCTIONAL GROUPS

1	CONTROL LEVER (STOP)
2	LEVER AND ACCELERATOR CABLE
3	HANDLE FIXING KNOB
4	AIR FILTER
5	MUFFLER
6	FUEL TANK CAP
7	INTERNAL COMBUSTION ENGINE
8	FINISHING HEADSTOCK
9	STABILIZING CIRCLE
10	ROTATING PULLEY DRIVE
11	BELT FIXING GUARD
12	TROWEL DISC
13	BLADE ANGLE ADJUSTMENT KNOB

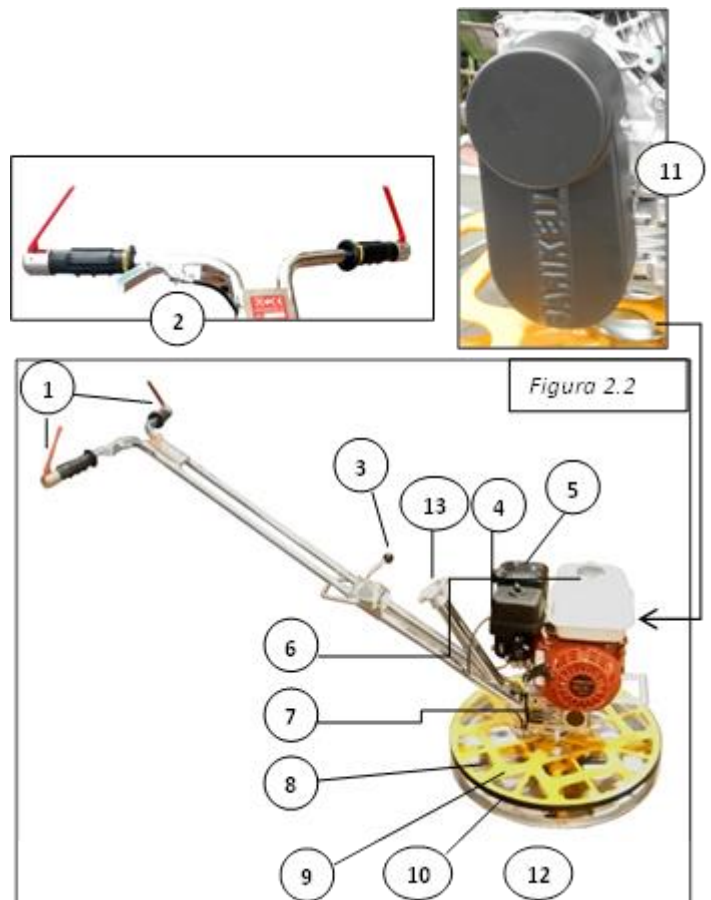

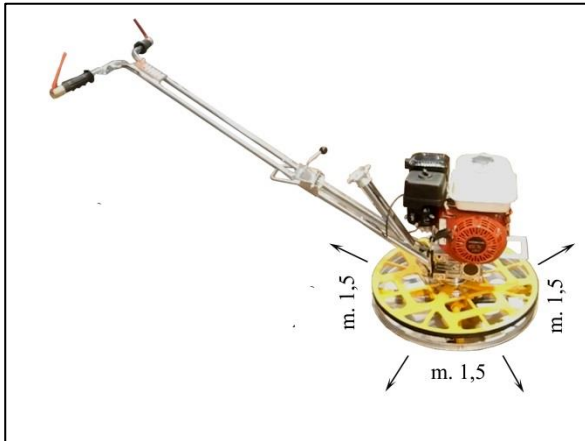

FIG. 2.3 Use and maintenance Area

2.7 TYPES OF POWER SUPPLY

IMPORTANT!

For more detailed information about the characteristics of engine refer to the manual of the component that is an integral part of this publication.

The machine must be powered by following the instructions given by **MBW**.

For safe operation read the following information carefully:

- The device is powered by an air-cooled petrol engine powered by unleaded petrol..
- The engines fitted to the machine can be of different types (see technical characteristics, p. 14).
- The engine is started by pulling.
- The fuel consists of lead-unleaded petrol that from the tank reaches the carburetor after being filtered.
- The rotation motion of the trowel blades is transmitted by the engine to a centrifugal clutch, connected with a trapezoidal belt to the rotor gearbox.

2.8 SAFETY MEASURES

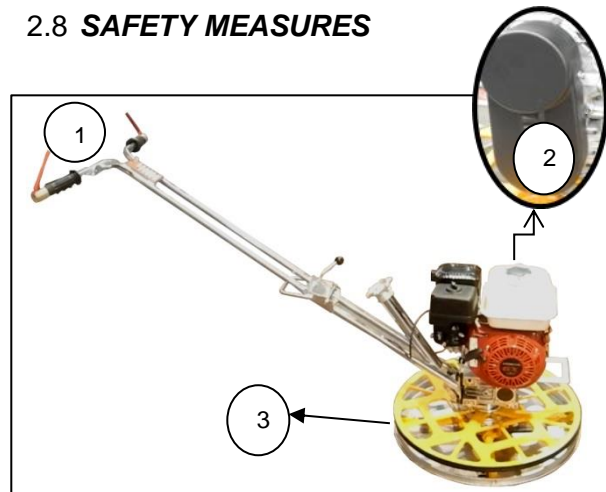

The safety measures included are:













































- 1) **Stop levers (maintained action commands)**
- 2) **Timing belt fixed guard**
- 3) **Fixed guards of blades segregation. Horizontal distance between handlebar and dangerous bodies equal to 900 mm.**































2.9 INFORMATION ON RESIDUAL RISKS























Despite the application, in the design phase, of the precepts contained in the safety requirements (RESS) provided for by current legislation and despite the activity of adopting safety measures, there is a residual risk that cannot be eliminated. Residual risks are appropriately reported through the application of specific **SAFETY SIGNALS** called **PICTOGRAMS** located at the danger zones. The pictograms have different informative values, namely:







- **WARNING SIGN: BLACK AND YELLOW TRIANGLE**
- **PROHIBITION SIGNS: WHITE AND RED CIRCLE**
- **SIGNS OF OBLIGATION: BLUE AND WHITE**

RESIDUAL RISKS ARE SUMMARIZED IN THE TABLES ON THE FOLLOWING PAGES (from page 17 to page 21).

RISKS	Reference Signs			SI	Residual Risks
	Danger	Prohibition	IPD		
MECHANICAL + PNEUMATIC					
Inadequate spaces					<p>It is forbidden to start the machine without connecting the float disc to the vanes as indicated in the user manual.</p> <p>There is a risk of entanglement, prohibited use of loose or fluttering clothing (are banned scarves, scarves, or ties non-adherent clothing).</p> <p>In case you need to replace the disc, you need to use protective gloves as some components (blades), if worn out, could be sharp.</p> <p>In case it is necessary to lift the machine (operation allowed only through the lifting hook supplied), first remove the trowel disk in as it could inadvertently disengage.</p> <p>It is mandatory to use the devices of individual protection required for the employee (safety shoes, gloves, mask).</p> <p>Before starting maintenance activities, carefully read the instructions in the user manual.</p> <p>It is prohibited to circumvent the safety devices implemented on the machine.</p>
Caught, entrapped, dragged		 		✓	
Crushing of upper limbs		 		✓	
Crushing of lower limbs				✓	
Shearing				✓	
Abrasions, cuts, punctures and/or perforations			 	✓	
Collisions, impacts and/or compressions with materials and equipment		 	 		
Slip, stumble and fall	  				
Collisions and/or impacts with transport means in transit	 		 		
Falling objects	 				
Projection of materials		  	 	✓	
Injuries deriving from poor lighting of spaces and/or working stations					
Projection of fluids at high pressure		 			

RISKS	Reference Signs			SI	Residual Risks
	Danger	Prohibition	IPD		
THERMAL					
Presence of heated surfaces, heat and flames		 	 	✓	Necessary to wait for the cooling of the engine and muffler surfaces before conducting maintenance activities. Use heat resistant gloves.
Scalds/burns caused by contacts with heated surfaces	 	 	 		
Presence of cold surface		 	 		
NOISE					
Localized noise		  		✓	Obligation to use DPI ear protectors
Background noise		 			
Injuries caused by interferences in verbal communication					
VIBRATIONS					
Vibrations transmitted to the whole body				✓	Obligation to use anti-vibration gloves. Limit exposure times
Vibrations transmitted to the complex hand-arm					

RISKS	Reference Signs			SI	Residual Risks
	Danger	Prohibition	IPD		
RADIATION					
Ionizing radiation					Not applicable.
Non-ionizing radiation, heat, light					
Laser equipment					
Exposure to Infrared and Ultraviolet Rays					
DIRECT AND INDIRECT ELECTRICAL					
Electrocution caused by direct and indirect contacts					Not applicable.
Electrostatic phenomena					
Electric arcs					
Injuries caused by failures in power supply and/or in the control system					
Exposure to electromagnetic fields					

RISKS	Reference Signs			SI	Residual Risks
	Danger	Prohibition	IPD		
FIRE AND EXPLOSION					
Fire and explosion				✓	The tank filling operations of petrol must be carried out in well ventilated environment and far from possible sources of heat or flames.
Presence of explosive atmospheres					
					
PHYSICAL WORKING LOAD					
Manual handling of loads					Not applicable.
Repeated actions of upper limbs					
Incorrect positions and/or excessive physical efforts					

RISKS	Reference Signs			SI	Residual Risks
	Danger	Prohibition	IPD		
CHEMICAL + BIOLOGICAL					
Injuries caused by the presence and use of stored chemical products					<p>The trowel activities must be carried out in environments with adequate ventilation.</p> <p>The use of protective devices is recommended for the protection of the airways.</p>
Splashes					
Ingestion					
Inhalation				✓	
Diseases caused by the presence of fluids, gases, fogs, fumes and powders					
Direct contacts					
Exposure to carcinogenic and mutagenic agents					
Exposure to asbestos					
Deliberated use of biological agents					
Accidental presence of biological agents					
Handling of potentially infected waste					

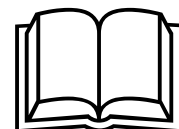

CHAPTER

3

3 TRANSPORT AND LIFTING

3.1 Packing and unpacking

3.2 Lifting and handling

3.3 Transport

3.4 Storage

3.5 Check for any damage to the machine

The operation of packing, handling, transport and unpacking must only be carried out by qualified personnel with perfect knowledge of the equipment to be used and safety rules and regulations. The means used for the handling, lifting and transport must be intact and capable of performing the required operations safely, taking into account the size, weight, projections, delicate parts and the center of gravity of the machine. Avoid improper uses and maneuvers, especially avoid maneuvers outside your field of competence and responsibility. Carry out handling and lifting using only the recommended means by harnessing the machines at the points indicated. **Always wear work gloves and safety shoes.** Do not place hands or other body parts under lifted components.

3.1 PACKING AND UNPACKING

The Trowel Machine Moskito remains intact at the time of packaging.

It is necessary to perform these operations when packing the machine:

- Fold the handle by means of the special lever (Fig. 3.1, a) and place the blades in a horizontal position using the adjustment knob (Fig. 3.1, b).

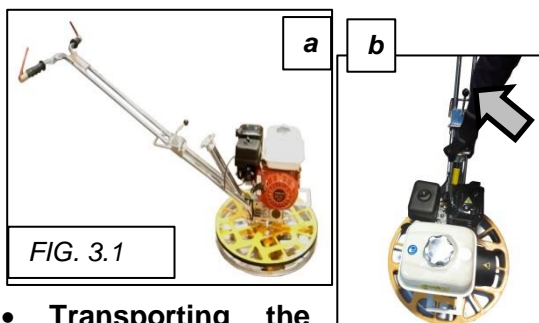

- **Transporting the trowel with inclined blades can damage the lifting blade system.**
- Remember to replace the disc to trowel blades to protect them from any dents before inserting into the packaging following the procedure given in PAR. 6.2.
- **Packing mode varies depending on the country of destination.**

- **United States:** A product for each box (fig 3.2) directly entered into the case.

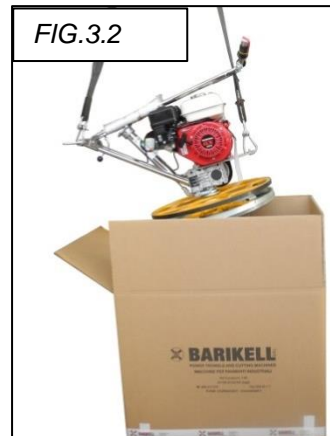

- **Italy:** Packing on wooden pallets with positioning latches, cover with polyurethane films (fig 3.3, a)
- **Other destinations:** Packing of one or more machines together inside a single box (fig 3.3, b) previously placed on wooden pallets with positioning stops.



WARNING

! Each element of waste must be collected and relocated in special container according to the guidelines for the collection of waste; released into the environment can be a source of pollution and danger.

- Lifting of the box containing the packaging must be carried out from below using an organ with a capacity suitable for the load to be lifted (homologated for a mass greater than or equal to that to be lifted).
- **The weight of the packaged product is shown in the table of general technical features on p. 14.**

3.2 LIFTING AND HANDLING

The total weight of the machine is ≤ 52 kg. Lifting must be performed from the top.



WARNING

The slinging / transport means must take into account the shape and volume as well as the mass indicated on the plate and / or in the machine data sheet.

Make use of ropes or straps and lifting bodies (crane or forklift truck) with a capacity greater than the one to be lifted.

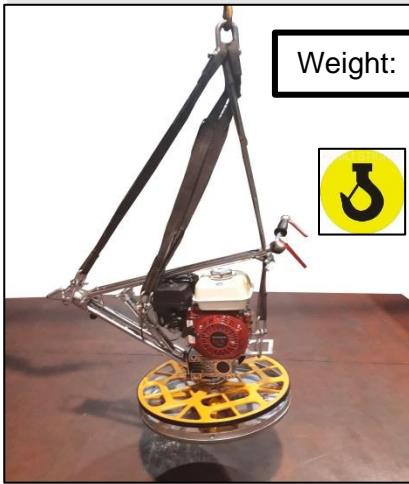

Weight: ≤ 52



ATTENTION

For lifting more than one meter from the ground, remember to remove the trowel disc before carrying out the lifting maneuver

1. Anchor the bands (in number of 2) to the two hooks placed at the two ends of the device in correspondence with the top-down hazard pictograms (fig 3.4)
Make use of hooks with safety lock which do not allow rope slipping.
2. Use a lifting tool (crane or forklift) connecting the appropriate organs to
3. these bands, putting cords/straps slowly in tension.
4. It is possible to equip the machine with an optional hook for lifting (eyebolt).
5. The lifting body must be approved for lifting, without imbalance, a load having a capacity greater than the total weight of the machine.
6. Lift the machine as close as possible to the ground and avoiding oblique lifting.
7. Carry out movements and maneuvers supported by a person on the ground

in charge of the alerts who must keep away from the suspended load.

3.3 TRANSPORT

Depending on the country of destination transport can be made with different media. The diagram below represents the most commonly used solutions.

In the case of transport by truck always check that the load does not protrude beyond the outline allowed by the highway code (height 4 m, width 2, 5 m).

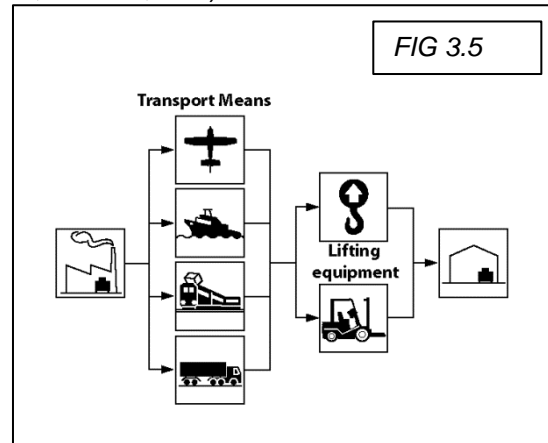

ATTENTION

In the case of road transport, the load of the vehicles must be arranged in such a way as to prevent the fall or the dispersion of the same, not to diminish the visibility of the driver or to prevent him from the freedom of driving movements, not to mask the lighting devices and the visual signalling, neither the identification plates and signals made with the arm (highway code art.164) and in compliance with the provisions of Directive 2014/17/EU.

3.4 STORAGE



ATTENTION

Firmly anchor the load to the means of transport in order to avoid sudden movements.

If the machine is not immediately installed, it should be stored in an environment with the same characteristics as the environment of use, in particular:

- Locate the parts of the machine away from areas subject to humidity or inclement weather;
- Always place between the floor and the components of the machine, wooden boards or otherwise, in order to avoid direct contact with the floor.
- In the event that a storage of more than one month is required, protect the unpainted parts (blades) with anti-oxidant products based on oils and fats.

3.5 DAMAGE CONTROL

Upon delivery of the machine, it is advisable that the staff in charge check that it is complete with all its parts and has not suffered any kind of damage.

Any damage must be immediately reported to the supplier.

The gear unit housing is sealed to the assembly; if you notice oil leaks, carefully observe where they come from because there may be leaks from other sources.

If the leaks come from the gear box, contact our technical service or a qualified contractor.

ATTENTION

!



During unloading from the means of transport and placement of the machine, the maneuvering area is only accessible to authorized persons.

Do not allow unauthorized personnel to stand near the machine during the lifting operations.

While performing these activities make use of appropriate PPE (personal protection devices): safety gloves & footwear



□

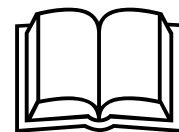

CHAPTER **4**

4 MACHINE INSTALLATION





- 4.1 Installation
- 4.2 Initial tests
- 4.3 General safety instructions
- 4.4 Starting the working cycle
 - 4.5 Trowel drive
 - 4.6 Trowel machine stop
 - 4.7 Restarting the trowel

The installation of the machine and the



ATTENTION

Environmental and operational conditions should not constitute an obstacle to access to the controls of the MACHINE. The location of the machine MUST be equipped with good lighting and must be free of shadows and glare that may create annoying phenomena for the operator. The minimum brightness level of the work area and of the intervention area for the execution of maintenance activities is 300 lux.

Related operations must be carried out only **by qualified personnel**.

- Always wear protective shoes;
- Never put your hands or other body parts under raised components or components that might move due to gravity;
- Do not wear rings, watches, bracelets, or dangling clothing during assembly and/or maintenance operations;
- Do not perform actions outside your field of knowledge and responsibility.

THE SYSTEM IN QUESTION CANNOT OPERATE IN AN EXPLOSIVE ATMOSPHERE.

4.1 INSTALLATION

The trowel machine is delivered properly placed into the packaging, with the handle folded upon itself.

After unloading the machine using a forklift from the means of transport and having completed the unloading and unpacking procedures:

- Place the machine on the floor;
- Open the handlebar and fix it in position by acting on the appropriate knob;
- To carry out the handling of the machine in the workplace, it is necessary to use a special lifting device whose capacity must be chosen in relation to the weight of the machine, indicated on page 23;



ATTENTION

It is recommended to NEVER raise the float using the rotating pulley.

- Upon receipt check the trowel machine has arrived intact. Otherwise contact our dealer (see paragraph 3.5).

INITIAL TESTS

The machine has been tested by the manufacturer. Before starting the following checks must be performed:

- Check the oil level in the engine and if necessary top off (check the engine maintenance manual);
- Check the level of fuel in the tank, (whose capacity is shown on page 14) by removing the cap. If necessary, fill the tank with clean petrol, using a funnel and a filter (refer to the engine manual for the correct filling procedure);

WARNING

It is recommended to make sure that there is no water in the gasoline and not to use gasoline mixture or diesel fuel. Perform this operation in a well-ventilated area away from possible sources of heat or flames. Make use of specific PPE (airway protection) as indicated in the table of residual risk on page 20 of this publication.



- Check that the degree of inclination of the blades is at least 1 cm in order to have greater control of the trowel at start-up. The machine is equipped with a graduated scale as shown in fig. 4.1 which allows to adjust accurately the degree of inclination of the blades by means of the knob (shown in FIG.);

- Before commanding the start of the trowel machine the operator must make sure that he is in good stability and has a good point of support to avoid sudden movements and possible loss of control of the machine both during the start and during the working phases;



- Check that the stop levers are operational;
- Start the machine by following the instructions in the next paragraph and release both levers at the same time to see if they work.



WARNING

To avoid slippage and loss of control of the trowel when starting the engine, the operator must always have a good foothold and a good grip in order to obtain full control of the machine, avoiding to generate situations of danger that could cause damage and injury to the operator. During the phases of work pay particular attention to possible loss of control of the trowel machine.

4.3 GENERAL SAFETY INSTRUCTIONS

Do not carry out repairs or maintenance when the machine is running.

WARNING



- ! Wear can make the blades of the trowel machine sharp enough to generate hazards for the operator. It is necessary to use protective gloves during all phases of maintenance and pay particular attention. During the working phases keep the limbs at a safe distance from the rotating parts and check that all the guards are present and efficient.

IMPORTANT!

In the case in which the work must be carried out on raised construction sites or on floors with holes and voids larger than 20cm x 20cm, it is necessary to install safety rails or barriers that have a minimum height of 100 cm from the floor to avoid that loss of control of the trowel and generate dangerous situations.

4.4 STARTING THE WORKING CYCLE



After performing the preliminary checks on startup described in the previous paragraph (para. 4.3) the machine can be started by following the instructions below:

- Mount the trowel disc on blades following the instructions provided in para. 6.2.3;
- With the trowel disc on the ground, lift the trowel with adequate lifting gear as described in PAR. 3.2 and lay it down on the disc;
- Engage the blades of the machine inside the tabs (2 or 4 depending on model) of the trowel disc;
- Place the engine start switch to ON-1 (FIG.4.2);

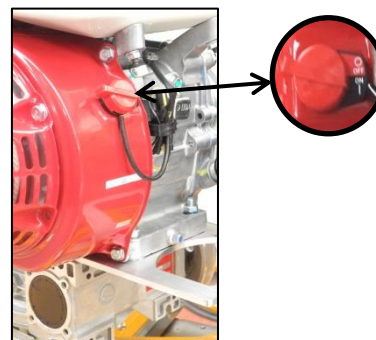
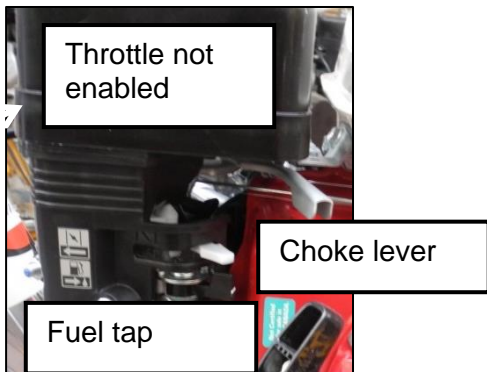

FIG. 4.2

- Close the choke lever (CHOKE);



- Position the throttle (Fig. 4.4) in the idle position (the lever is provided with specific indications for use: **(on and off arrow, Fig. 4.4)**;

IMPORTANT!

The only working accelerator lever is the upper one (the lower one on the engine has been disabled during manufacturing).

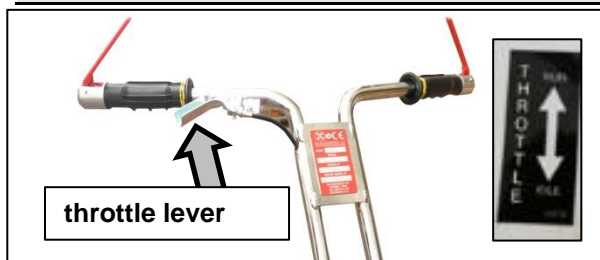

FIG.4.4

- The engine start is damaged: pull the rewind rope on the engine (Fig. 4.5);



- When the engine has started, open the choke lever, moving it to the right as shown in FIG. 4.3;

- The engine is started at reduced speeds, the clutch has not yet started and the rotor does not rotate yet;
- To avoid damaging frictional slippages that could wear it out, firmly place the accelerator at a speed value of 2500 rpm;
- The trowel work must be carried out keeping the handlebar of the machine firmly and constantly holding down a command with a maintained action (stop lever).

ATTENTION

In the event of immediate danger to the operator, such as loss of control of the trowel, immediately release the stop levers.

4.5 TROWEL DRIVE

To carry out the displacement of the trowel machine it is necessary that the operator acts on the handlebar according to the following procedures:

- Push the handlebar down to make a shift to the right;
- Push the handlebar up to make a shift to the left;
- Push the handlebar forward to make a shift forward;
- Pull the handle back to make one move backward.

The release of the maintained action control (emergency stop, see fig. 4.4), involves an immediate arrest of trowel.

4.6 TROWEL MACHINE STOP

To stop the trowel operate as follows:

- Release the command with maintained action (stop levers);
- Stop levers are connected to two microswitches which interrupt the current to the spark plugs;
- Close the fuel tap by turning the black lever shown in FIG. 4.3;

IMPORTANT!

Before stopping the machine, intervene on the accelerator and take it to a minimum.

4.7 RESTARTING THE TROWEL

To restart the machine it is necessary to repeat the start procedure (see paragraph 4.4).

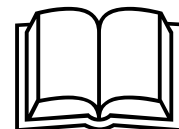

CHAPTER **5**

5 USE OF THE TROWEL MACHINE

5.1 Surface preparation

5.2 Troweling phase

5.3 Finishing phase

5.1 SURFACE PREPARATION



WARNING

Operation of the machine, the user must be aware that moving parts are dangerous; therefore, to avoid damage, it is important to follow the instructions given in this manual.



Carefully read the instructions and warnings reflected in this manual.

We recommend the use of a vibrating mechanical screed or manual screed to level the floor surface. This preliminary operation will give a good compaction to concrete screed and as a result you will get an ideal surface for the troweling and finishing.

TROWELING PHASE

IMPORTANT!

Carefully consider that the trowel machine DOES NOT improve the flatness of a badly levelled floor.

Before starting the troweling operation, make sure that the trowel disc has been correctly mounted on the blades.

The floor will be ready for the first troweling when walking on the same the footprint of the shoe sinks about 2-3mm into the concrete.

During the troweling phase the trowel disc does not have to jump on the surface; this phenomenon could be due to the dirt nested between the blades and the trowel disc.

If necessary, stop the trowel and clean it as indicated in the next paragraph.

The intervals of the trowel passes depend on environmental factors, namely: temperature and weather conditions. On average about 20-30 square metres of surface are troweled in ten minutes.

After each operation, stop the engine.

Never leave the machine stopped with the engine running, especially during the troweling phase when the concrete is still fresh. **Be careful not to work continuously in the**

same spot when the concrete is still wet, as it may cause damage to the flatness of the floor.

5.3 FINISHING PHASE

After troweling:

- Remove the trowel disc from the blades and clean the blades and the blade holder from the cement deposited during the troweling phase (use PPE);
- Turn the lift-rod knob (detail of Fig. 5.1) clockwise until a tilt of about 1 cm is given to the blades to perform the first pass;

WARNING



Never lift the trowel holding the rotating pulley. Use a special lifting device to move it. In case it is necessary to lift it more than cm. 100 from the ground, remove the trowel disc as described in para. 6.2.

- For subsequent smoothing operations continue increasing the inclination of the blades until you obtain the desired finish;
- The time between one pass and the other is determined by the weather conditions (cold or warm season) and the amount of water present in the concrete; If in some areas the concrete has hardened too quickly it is possible to dampen by spraying a small quantity of water with a masonry brush to obtain the desired degree of finish.

WARNING



In the presence of too much water the trowel tends to skate; it is compulsory to make sure, especially at the time of start, you always have control of the machine.

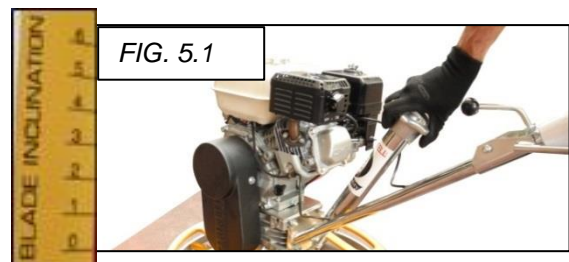
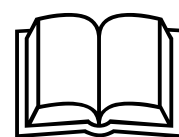

FIG. 5.1



CHAPTER

6

6 MAINTENANCE AND REPAIRS

- 6.1 Scheduled maintenance**
- 6.2 Routine and additional maintenance**
- 6.3 Problems and remedies**

Therefore during maintenance check carefully



ATTENTION



During the execution of the maintenance tasks you must wear the following PPE: **CUT RESISTANT GLOVES AND SAFETY SHOES.**

For certain types of activities (supply of lubricant) make use of airway protective equipment as indicated in the residual risks.



Calzature di sicurezza obbligatoria



Guanti di protezione obbligatoria

Before servicing the machine, make sure you understand the contents of this manual. For questions and information please contact the manufacturer. Maintenance workers must possess the skills required by this manual, as well as mental and physical requirements necessary and sufficient to intervene on the machine. In order to guarantee the functionality and the duration of the same, its periodic maintenance must be carried out constantly, performing the operations always in compliance with the safety prescriptions.

Only the dealer (authorized workshop) can make adjustments and interventions that are not assigned to the operator. It is forbidden to make adjustments and interventions during machine operation. Before performing any maintenance operation, disconnect the machine from power sources:

1. To stop put the accelerator to a minimum, by acting on the throttle lever.
2. Release both stop levers (red ones).
3. Close the fuel tap.
4. Switch the engine to off (position switch to OFF/0).
5. Carry out the maintenance operations with the machine stopped.

1. Thoroughly clean the trowel because due to wear the blades can become sharper.

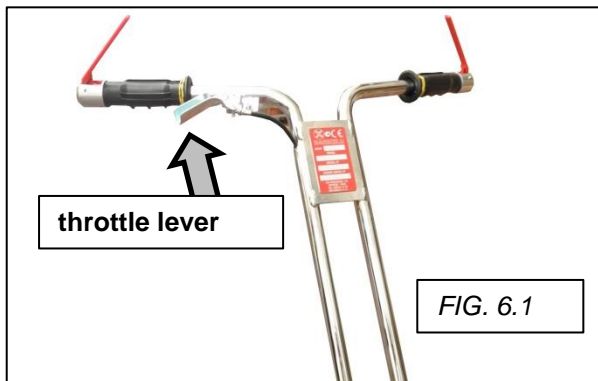

their position and adopt anti-cut gloves.

2. If in doubt about how to perform occasional repairs contact our support department or authorized workshop.
3. At the end of the work perform a thorough cleaning from scraps.
4. At the conclusion of the work after cleaning, replace the trowel disc under the blades to protect them from damage caused by movement of the machine.

WARNING











Some operations of maintenance / replacement of worn components can only be carried out by the manufacturer's technician. They are reported later in this publication. Please note that failure to comply with the requirements of maintenance sets up the hypothesis of misuse or prohibited use and releases the manufacturer of all responsibility for damage to persons and property.





6.1 SCHEDULED MAINTENANCE





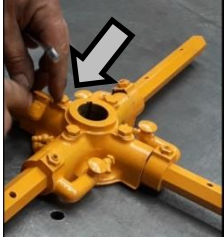

Good maintenance requires steady and methodical control of all parts of the machine and adjustment of the checks to its actual use. Periodic inspections are of paramount importance to keep the machine efficient and reduce repairs and the dangers that could result.

It is advisable to have the retailer's technician (AUTHORIZED WORKSHOP) perform an annual general check.

Note: The frequency is taken into account considering the 8-hour working day.

OPERATION NAME	FREQUENCY	APPOINTEE	OPERATING INSTRUCTIONS	MACHINIST ATUS
MECHANICAL PARTS				
Check of the blades bolts status and tightening	Daily		 Check the status of the blade bolts. Perform the tightness daily. If the bolts are worn, replace them. The bolts can be replaced by a wrench of adequate length with the machine on the ground, in a vertical position.	Machine stopped/ cut energy
Engine air filter cleaning	Daily		Clean engine air filter, especially when working in dusty conditions; follow the instructions in the engine manual.	Machine stopped/ cut energy
Check belt wear status and tension degree (check rotor operation)	Weekly		Follow the procedures in para 6.2.4 in case of breakage or significant wear of the belt to provide for replacement.	Machine stopped/ cut energy
Spark plug cleaning	Weekly		<p>If it is necessary to replace them, refer to the engine manual attached to this publication.</p>  <p>Be careful when removing the spark plug:</p> <ul style="list-style-type: none"> • Remove the cap • Remove the spark plug • Wait until the engine has cooled and then lay the spark plug removed away from the holder (because it might trigger sparks). 	Machine stopped/ cut energy
Check wear of the clutch	Weekly		In the event it is necessary to replace the braking mass, it is mandatory to have the dealer intervention (authorized workshop)	
Visual inspection and possible replacement of the trowel disc	Monthly		 Visually inspect the state of wear of the disc surface. If the disc has undergone an expansion, action is needed to replace it (SEE PAR. 6.2.3).	Machine stopped/ cut energy

<p>Reducer</p>	<p>If necessary</p>	<p>In case of non-resolvable breakages or faults requiring the replacement of the component, REFER TO A SPECIALIZED WORKER (AUTHORIZED DEALER).</p>	<p>The gear unit housing is sealed to the assembly; if you notice oil leaks, carefully observe where they come from because there may be leaks from other sources. If the leaks come from the gear box, contact our technical service or a qualified contractor. The gearbox is lubricated for life. The oil should not be topped off. For a possible change of the lubricant due to leaks, use SYNTHETIC OIL FOR LONG LIFE REDUCERS ISO VG320 GRADING.</p> <div style="border: 1px solid black; padding: 5px; background-color: #f0f0f0;"> <p>WARNING IT IS FORBIDDEN TO REPLACE THE GEAR-BOX. REFER TO THE MANUFACTURER OR THE RETAILER (SPECIALIZED MAINTENANCE TECHNICIAN).</p> </div>	<p>Machine stopped/ cut energy</p>
<p>Check of blades wear status and replacement if necessary</p>	<p>Daily</p>		<p>Follow the procedures in para 6.2.1 for replacement</p>	<p>Machine stopped/ cut energy</p>
<p>Recording of blades inclination grade</p>	<p>It is advisable to periodically record the degree of inclination of the blades</p>		<p>On the bench, turn the adjusting screw and adjust the angle of the blades. The operation can be carried out with the machine mounted with long wrenches.</p> 	<p>Machine stopped/ cut energy</p>
<p>Unlocking arms of blades and pressure plate</p>	<p>If necessary</p>		<p>Follow the procedures in para 6.2.2</p>	<p>Machine stopped/ cut energy</p>
<p>Check gasoline level and supply</p>	<p>Each start</p>	 <p>Check the level of fuel in the tank, (whose capacity is</p>	<div style="border: 1px solid black; padding: 5px; background-color: #f0f0f0;"> <p>ATTENTION It is recommended to make sure that there is no water in the gasoline and not to use gasoline mixture</p> </div>	<p>Machine stopped/ cut energy</p>

		indicated in the technical data) by removing the cap. If necessary fill the tank with clean fuel, using a funnel and a filter.	<p>or diesel fuel. Perform this operation in a well ventilated area away from possible sources of heat or flames. Make use of specific PPE (mask) as indicated in the table of residual risk on page 20 of this publication</p> 	
Engine oil level check and possible replacement	Daily		Check manufacturer's instructions present in the manual of the component (attached to this publication)	Machine stopped/ cut energy
Fork replacement	Where needed (in case of breakage, see drawbacks)		This task must be performed exclusively by a qualified operator (DEALER/SPECIALIST WORKSHOP)	Machine stopped/ cut energy
SAFETY SYSTEMS				
SAFETY SYSTEMS (BELT GUARD)	Every 6 months			Machine stopped/ cut energy
CHECK PICTOGRAMS INTEGRITY	At the beginning of the shift			Machine stopped/ cut energy
CHECK CONTROL LEVERS INTERVENTION	At the beginning of the shift			Machine in function

6.2 ROUTINE AND ADDITIONAL MAINTENANCE

6.2.1 Blades replacement



Check the state of wear of the blades or if they have been damaged or bent. To replace blades perform the following steps:

- Clean the trowel from any processing residue;
- Remove the attachment bolts (hex head 6x35) of the blades on each arm of the trowel machine (2 for each arm) (FIG. 6.2) by means of a suitable tool and long enough to do this on the ground with assembled machine;

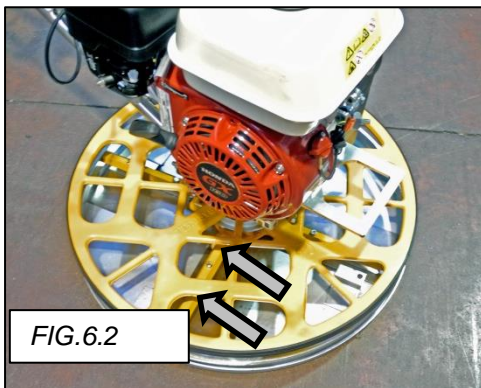

- Fit the new blades fixing bolts with their split rings.

IMPORTANT!

For correct operation of the trowel machine, in case of breakage or damage of one or more blades, replace all of them.

6.2.2 Unlocking of blades holding arms and pressure plate

As indicated in para. 6.3 in the event that the tilt control does not work, this drawback may be due to a blockage of the blades-holding arms or of the pressure plate.



Unlocking of blades holding arms and pressure plate and replacement of blades holding arms if necessary.

To unblock the blades and the pressure plate refer to the dealer (authorized workshop).

6.2.3 Trowel disc replacement

The trowel disc is subject to wear which manifests itself through an enlargement of the same.

If, as a result of a visual inspection, this happens, replace the disc.

Proceed as follows:



- Unhook the blades out of the hooking tabs (the tabs on the trowel disc are 2 or 4 depending on the number of blades), slightly raising the machine by leveraging the two hooks as shown in FIG. 6.3;

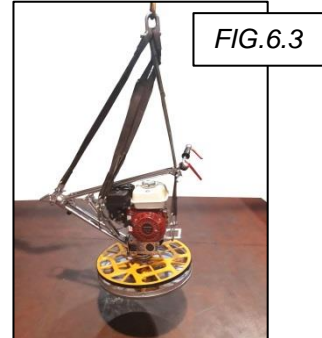

- The trowel disc remains on the ground once released from the blades (Fig. 6.3.1-2);

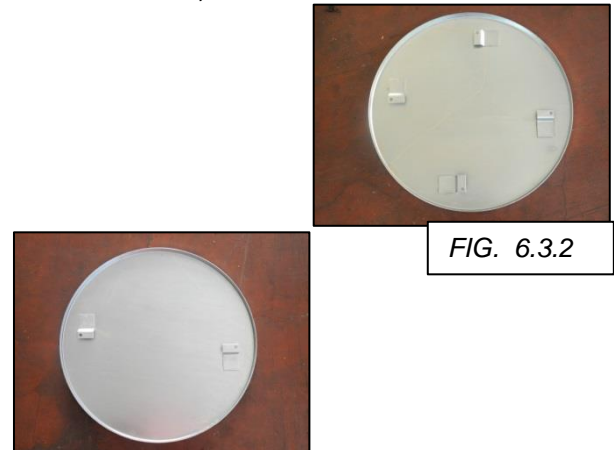

FIG. 6.3.1

FIG. 6.3.2

- Perform disc replacement and reposition the machine on the new disc by moving it from above with adequate lifting body;
- Replace the tabs of the new disc to the blades, proceeding backwards with respect to the coupling maneuver.

ATTENTION



Use an appropriate lifting body to handle the trowel. During the cleaning of the blades and the blade disc to be carried out with the blades fitted, it is compulsory to wear the appropriate PPE (protective gloves with mechanical agents and safety shoes).

6.2.4 Replacing the belt

If, following a visual inspection, it emerges that the belt is worn or broken, replace it operating as follows:

- Wait for the engine to cool;
- Remove the fixed segregation guard of the belt by unscrewing the 2 hexagonal head screws and the 2 washers (Fig. 6.4) by means of a T-wrench;

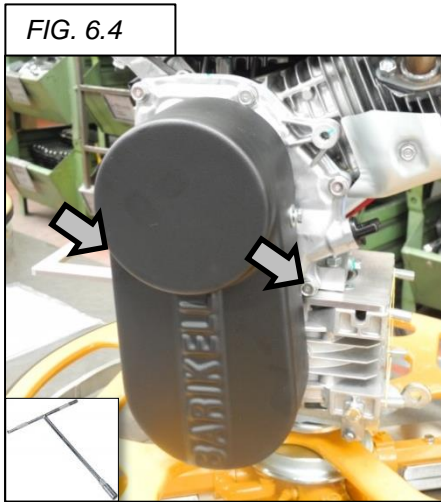

- Replace the belt as shown like in FIG. 6.5, by turning the pulley and remove the belt (fig. 6.5, b);

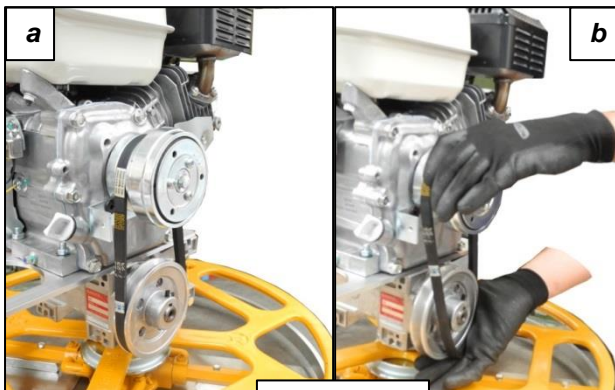

- Fit the new belt by turning the pulley to position it correctly;
- Reassemble the fixed segregation guard of the belt previously disassembled.

6.2.5 Refill of engine oil

If necessary (if the visual check results in a lack of oil), top off the lubricant.

The topping can be performed when the machine is mounted and in upright position.

- Remove the oil filler cap and dipstick and clean (Fig. 6.6 a);
- Reinsert the cap without screw and remove it to check the oil level;
- If the oil level is near or below the minimum detectable on the dipstick, refill with the oil recommended by the manufacturer;
- By means of a funnel-shaped carafe insert the oil in the tank (c);
- Insert the cap/dipstick and close it.

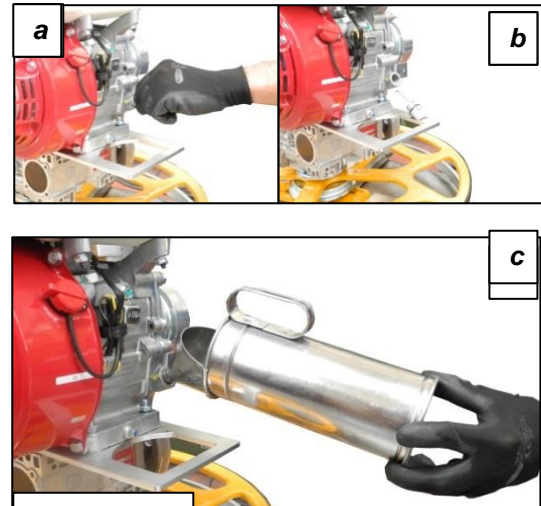

FIG. 6.6

IMPORTANT!

Check the operator's manual for more information about topping off of the engine oil and the type of oil to use.

Wait for the engine to cool before performing the maneuver

6.2.6 Gear motor oil topping off

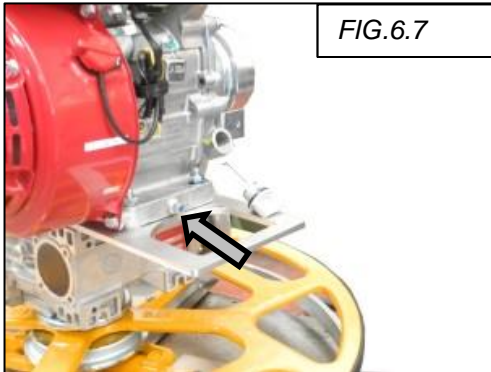
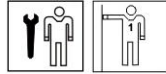

FIG. 6.7

The gearbox is lubricated for life, therefore it does not need to be topped off in theory. If this operation is necessary due to losses, it can be carried out with machine in vertical position.

- When the machine is stopped, wait until the engine has cooled down;
- Insert the lubricant into the cap indicated in FIG. 6.10 using a funnel of suitable size.

IMPORTANT!

**TO AVOID DAMAGE TO THE MACHINE STRICTLY USE THE FOLLOWING TYPE OF LUBRICANT:
SYNTHETIC OIL FOR LONG DURATION REDUCERS ISO VG320.**

want to proceed with the dismantling of the various machine parts, you must pay attention to their handling, taking into account the respective masses to be moved. Even in the case of machines used in the workplace it is necessary to dispose of electrical and electronic products contained in them, if any, according to the regulations in force. The current European legislation requires that these kinds of waste are disposed of according to specific procedures.

IMPORTANT

Do not disperse non-biodegradable products, lubricating oils and related filters (if any) and non-ferrous components (rubber, PVC, etc.) into the environment.



Dispose of them in compliance with the laws in force and before proceeding to disposal, consult the retailer in order to check if there are specific programs of collection.

IMPORTANT

During dismantling, user is required to collect the equipment identification plate to prevent the machine from being re-commissioned without the guards, since the responsibility is **NO MORE OF THE MANUFACTURER**

6.2.7 Notes about dismantling

With regard to dismantling activities, there are no environmental or safety problems. If you

6.3 TROUBLESHOOTING

ISSUES	CAUSES	REMEDIES
The rotor does not turn at desired speed	<ol style="list-style-type: none"> 1. Slow or worn belt 2. Worn clutch 	<ol style="list-style-type: none"> 1. Replace belt 2. Replace braking masses (by the dealer and / or specialised workshop)
The trowel machine does not work as desired	<ol style="list-style-type: none"> 1. Excessively worn blades 2. Disc not tight to the trowel body 	<ol style="list-style-type: none"> 1. Replace blades 2. Check for dirt or other under the trowel machine body
The trowel leaves circular traces	<ol style="list-style-type: none"> 1. Dirty blades or disc 2. Worn blades or disc 	<ol style="list-style-type: none"> 1. Clean 2. Replace the blades or disc
The trowel vibrates	Engine bolts or other parts of the trowel machine too loosen	Check and tighten any loosen bolts
The trowel machine oscillates during operation	<ol style="list-style-type: none"> 1. The blades are not adjusted correctly 2. One or more holding blades arm are bent 	<ol style="list-style-type: none"> 1. Set/adjust the blade (page 34) 2. Replace folded arms (intervention by dealer/specialist workshop)
The lift-off command does not work	<ol style="list-style-type: none"> 1. Blades holding arms blocked or locked bell 2. Residues of cement on the moving parts of the cruise 3. Lifting blades knob dirty or blocked 4. Broken fork 	<ol style="list-style-type: none"> 1. Unlock the bell or arms (page 36, authorized workshop/dealer) 2. Remove cement residues 3. Control lifting blades group 4. Replace fork (dealer/specialist workshop)
Engine does not start	<ol style="list-style-type: none"> 1. No fuel 2. No power to spark plug 3. Open choke 4. Retaining levers inserted 5. No oil in the engine (oil alert) 	<ol style="list-style-type: none"> 1. Refuel 2. Check if there is power to spark plug 3. Pull choke. 4. Switch off stop levers 5. Perform oil top off
Leaving the emergency stop lever the trowel doesn't stop	<ol style="list-style-type: none"> 1. Loose or damaged wires 2. Broken microswitch 	<ol style="list-style-type: none"> 1. Fasten wires or replace the wires (retailer) 2. Replace the entire stop lever assembly as soon as the microswitch is welded with the resin, by the dealer

6.4 PARTS LIST

MOSKITO 4-60

**TABLE
TAVOLA A**

ENGINE / MOTORE HONDA COD.3000 - 3005
ENGINE / MOTORE ROBIN COD.3008 - 3012
ENGINE / MOTORE RATO COD.3018

U.S.A. market

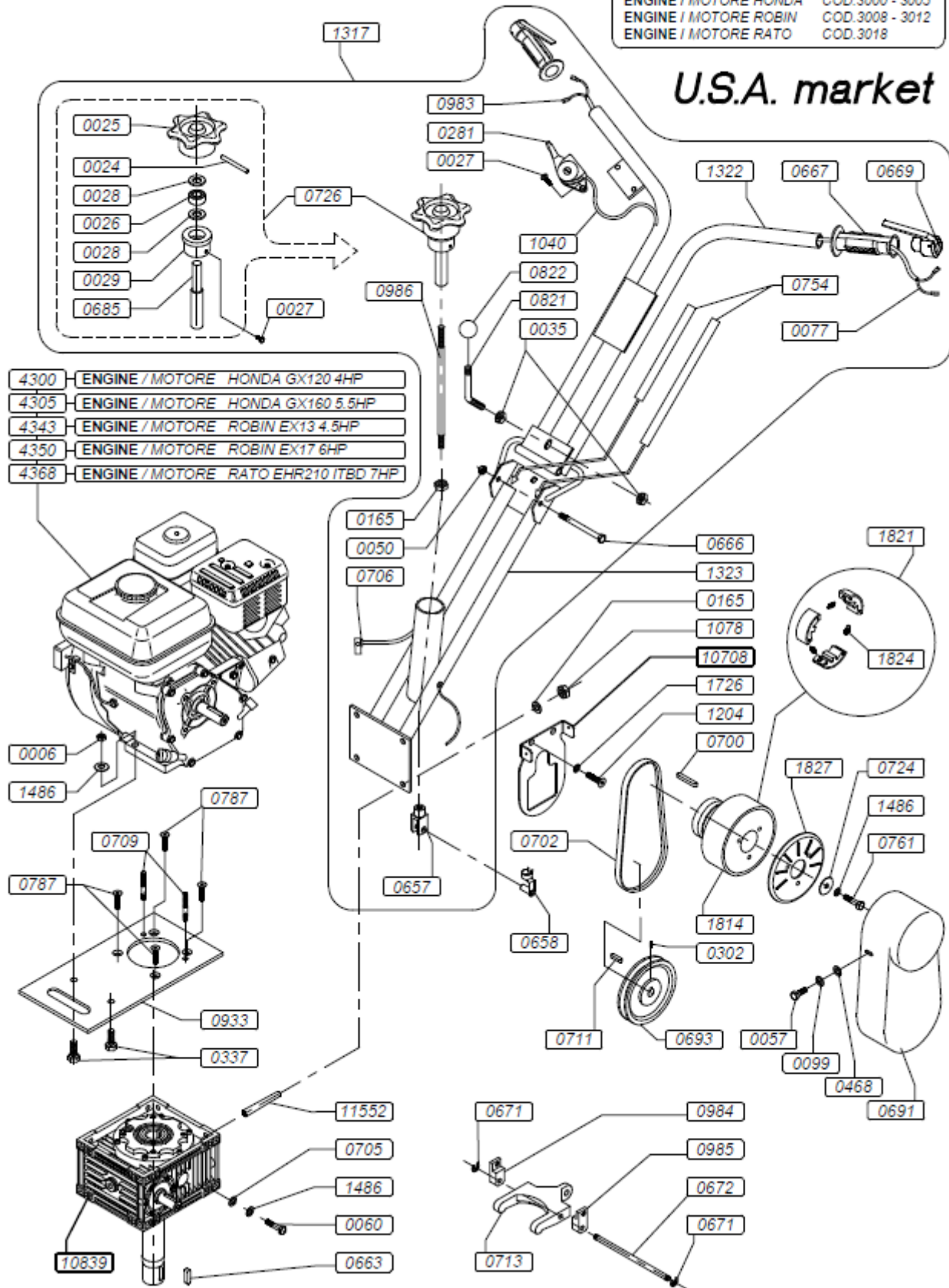

COD.	DESCRIZIONE (I)	DESCRIPTION (GB)
0006	DADO M8 UNI 5588 Z.B.	NUT M8 UNI 5588 ZINC PLATED
0024	SPINA ELASTICA 6x60 DIN 1481	UNIVERSAL PIN 6x60 DIN 1481
0025	MANOPOLA ALZAPALE	TOOLHOLDERS KNOB
0026	CUSCINETTO REGGISPINTA AXK1528	BEARING THRUST AXK1528
0027	VITE TCCE 5x10 5931 Z.B.	SCREW TCCE 5x10 5931 ZINC PLATED
0028	RALLA AS 1528	BOLSTER AS 1528
0029	ANELLO PORTACUSC.REGGISPINTA	RING BEARING THRUST
0035	DADO BLOKM10 -985 - Z.B.	SELF-LOCKING NUT M10 985 ZINC P.
0050	DADO BLOKM8 DIN 985 Z.B.	SELF-LOCKING NUT M8 DIN 985 ZINC P.
0057	VITE TE 6x12 5739 Z.B.	SCREW TE 6x12 5739 ZINC PLATED
0060	VITE TE 8x25 - 5739 - Z.B.	SCREW TE 8x25 - 5739 ZINC PLATED
0077	FILO ELETTRICO L=2600	ELECTRIC WIRE L=2600
0099	RONDELLA GROWER D. 6 Z.B.	WASHER D. 6 ZINC PLATED
0165	DADO M10 5589 BASSO - Z.B.	NUT M10 5589 ZINC PLATED
0281	LEVA ACCELERATORE METALLO	METAL ACCELERATOR LEVER
0302	GRANO M6x16 - 5927	DOWEL M6x16 - 5927
0337	VITE TE 8x40 5737 Z.B.	SCREW HEX HEAD 8x40 5737 ZINC P.
0468	RONDELLA 6x18X1,5 Z.B.	WASHER 6x18X1,5 ZINC PLATED
0657	FORCELLA UNI 1676 - DIN 71752	YOKE UNI 1676 - DIN 71752
0658	CLIPS PERFORCELLE M10	CLIPS FOR YOKE M10
0663	CHIAVETTA 6x6X25 6604A	KEY 6x6X25 6604A
0666	VITE TE 8x110 5737 ZINCATA B.	SCREW HEX HEAD 8x110 5737 ZINC P.
0667	MANOPOLA D. 22 APERTA RIF.1MA04005	KNOB D. 22 RIF.1MA04005
0669	DISP.SIC.BENZ.D.18 S/GANCIO (1DS01005)	FUEL SECURITY D.18 (1DS01005)
0671	SEEGER "E" 8 - UNI 7435	SEEGER "E" 8 - UNI 7435
0672	PERNO D.8 L=145 PER FORCELLA Z.B.	PIN D.8 L=145 PER YOKE ZINC PLATED
0685	CILINDRO ALZAPALE MOSKITO Z.B.	LIFTING CYLINDER MOSKITO ZINC P.
0691	CARTER PROTEZ. CINGHIA M60/M75	CASING PROTECTION BELT M60/M75
0693	PULEGGIA ALLUMINIO 112x1A D.19 H7	PULLEY ALLUMINIUM 112x1A D.19 H7
0700	CHIAVETTA 4,7x4,7 L=37	KEY 4,7x4,7 L=37
0702	CINGHIA PIBELT A23	PIBELT A23
0705	RONDELLA PIANA D. 8 Z.B.	WASHER D. 8 ZINC PLATED
0706	MORSETTO PER FILO ACCELERATORE	CLAMP FOR ACCELERATOR WIRE
0709	PRIGIONIERO M8 L=40 Z.B.	STUD M8 L=40 ZINC PLATED
0711	CHIAVETTA 6x6x30 - 6604A	KEY 6x6x30 - 6604A
0713	FORCELLA MOSKITO Z.B.	YOKE MOSKITO ZINC PLATED
0724	RONDELLA 8x24 - ZINCATA BIANCA	WASHER 8x24 - ZINC PLATED
0726	BLOCCO ALZAPALE PER MOSKITO	BLADE LIFTER UNIT MOSKITO
0754	TUBO ARMORVIN HNA 10 RIF. RPQ0191	PIPE ARMORVIN HNA 10 RIF. RPQ0191
0761	VITE TE UNF 5/16x1	SCREW HEX HEAD UNF 5/16x1
0787	VITE VSP 8x20 5933 Z.B.	SCREW VSP 8x20 5933 ZINC PLATED
0821	PERNO BLOC. MANICO M10 L=165 Z.B.	PIN LOCK HANDLE M10 L=165 ZINC P.
0822	POMELLO ASFERA M10	BALL KNOB M10
0933	PIASTRA RID. 4-60/4-75/6-60/6-75	REDUCTION GEAR PLATE 4-60/4-75/6-60/6-75
0983	FILO ELETTRICO L=680 + G.COR	ELECTRIC WIRE L=680

0984	SUPPORTO DX FORCELLA NRV	SUPPORT RIGHT YOKE NRV
0985	SUPPORTO SX FORCELLA NRV	SUPPORT LEFT YOKE NRV
0986	TIRANTE M10 L=300 Z.B. 4-60/75	TIEROD M10 L=300 Z.B. 4-60/75
1040	FILO C/GUAINA 1,5x1900x1800 -	CABLE WITH SHEATH 1,5x1900x1800
10708	STAFFA PER CARTER PROTEZ.4-60 USA	CLAMP CASING 4-60 FOR USA MARKET
1078	RONDELLA ZIGRIN.D10 ZINC.B.	WASHER D10 ZINC PLATED
11552	PRIGIONIERO M10X1.5-1.25 X RID. MOSKITO	STUD M10X1.5-1.25
1204	VITE TSPCE UNF 12.9 5/16 X 5/8	SCREW TSPCE UNF 12.9 5/16 X 5/8
1317	MANICO MOSKITO COMPL.4-60/6-60	COMPLETE HANDLE FOR MOSKITO 4-60/6-60
1322	MANICO SUPERIORE CROM. MOSKITO	UPPER HANDLE CHROME MOSKITO
1323	MANICO INFERIORE CROM. MOSKITO	LOWER HANDLE CHROME MOSKITO
1486	RONDELLA ZIGRINATA D.8 Z.B.	WASHER D.8 ZINC PLATED
1726	RONDELLA D.8 DENTATA CONICA	TAPERED WASHER D.8
1814	FRIZIONE MOSKITO 75 D.19,05 (3./4")	CLUTCH 75 D.19,05 (3./4")
1821	SERIE MASSE FRIZIONE BARIKELL	FLYWEIGHT FOR CLUTCH BARIKELL
1824	MOLLA X FRIZIONE BARIKELL 75	SPRING FOR CLUTCH BARIKELL 75
1827	COPERCHIO FRIZIONE BARIKELL 75	CLUTCH COVER BARIKELL 75
4300	MOT. HONDA 4HP GX120UT2 QX-4 OH	ENGINE HONDA 4HP GX120UT2 QX-4 OH
4305	MOT. HONDA 5,5HP GX160H1 QX-3 OH	ENGINE HONDA 5,5HP GX160H1 QX-3 OH
4343	MOTORE ROBIN/SUBARU EX13 4,5HP	ENGINE ROBIN/SUBARU EX13 4,5HP
4350	MOTORE ROBIN/SUBARU EX17 6HP	ENGINE ROBIN/SUBARU EX17 6HP
10839	RIDUTTORE RT 60 B3 1:20 VITE S.FINE NERO	REDUCTION GEAR RT 60 B3 1:20 WORM SCREW BLACK

MOSKITO 4-60

TABLE TAVOLA **B**

ENGINE / MOTORE HONDA	COD.3000 - 3005
ENGINE / MOTORE ROBIN	COD.3008 - 3012
ENGINE / MOTORE RATO	COD.3018

U.S.A. market

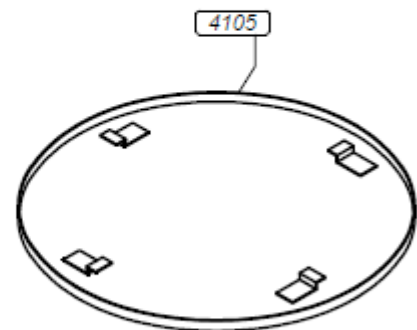
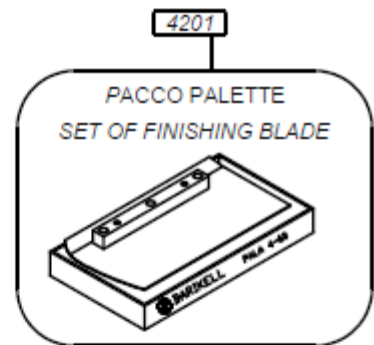
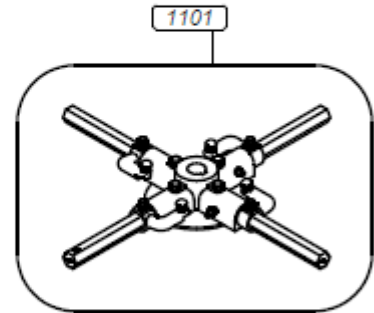
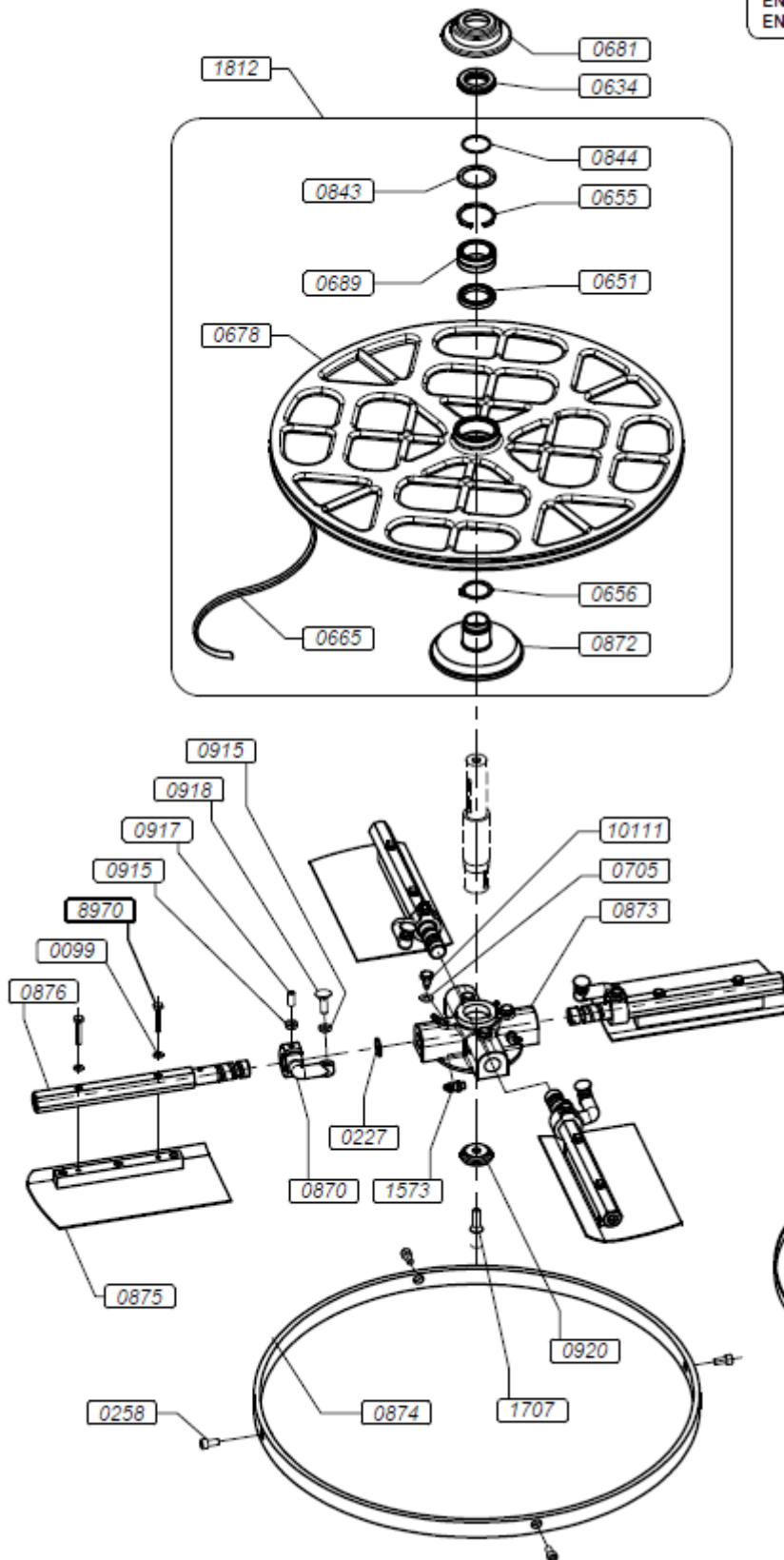

COD.	DESCRIZIONE (I)	DESCRIPTION (GB)
0099	RONDELLA GROWER D. 6 Z.B.	WASHER D. 6 ZINC PLATED
0227	OR D.20 SEZ.1,5 PER CROC.	O-RING D.20 SEZ.1,5
0258	VITE TCCE 8x16 UNI 5931 Z.B. 12.9	SCREW TCCE 8x16 UNI 5931 ZINC PLATED
0634	CUSCIN.ASS. A SFERE 51107 CX	BALL BEARING 51107 CX
0651	CUSCINETTO 61808 2RS	BEARING 61808 2RS
0655	SEEGER "I" TIPO JV - 55	SEEGER "I" TYPE JV - 55
0656	SEEGER RW40 - 7433	SEEGER RW40 - 7433
0665	PROTEZIONE PER DISCO PULEG.D.600	PROTECTION FOR PULLEY DISK Ø600
0678	DISCO PULEGGIA DIAM.600	PULLEY DISC d. 600
0681	PIATTO COPRICUSCINETTO MOSKITO	PLAT BEARING CAP MOSKITO
0689	CUSCINETTO NKI 40/20	BEARING NKI 40/20
0705	RONDELLA PIANA D. 8 Z.B.	WASHER D. 8 ZINC PLATED
0843	COPRICUSCINETTO IN PLASTICA PER MOSKITO	COVER BEARING FOR MOSKITO
0844	OR D.40 SEZ. 2 PER MOSKITO	OR D.40 SEZ. 2 FOR MOSKITO
0870	GOMITO GHISA D20 MOSKITO 60-75	BEND CAST IRON D20 MOSKITO
0872	CAMPANA 4-60/6-60/4-75/6-75	HEAD 4-60/6-60/4-75/6-75
0873	CROCIERA 4-60 / 4-75	SPIDER 4-60 / 4-75
0874	CERCHIO STABILIZZATORE 4-60	STABILIZER PLATE 4-60
0875	FRATTAZZI 4-60	BLADE UNIT 4-60
0876	BRACCIO PORTA PALETTE 4-60	BEND FOR TOOL HOLDER 4-60
0915	DADO M8 5589 BASSO GREZZO	NUT M8 5589 ROUGH
0917	GRANO 8x20 A PUNTA - 5927	DOWEL 8x20 5527
0918	VITE TTDE 8x25 UNI 5731 SENZA	SCREW TTDE 8x25 UNI 5731
0920	RONDELLA FISS.CROCERA MOSKITO	WASHER FIX SPIDER MOSKITO
1101	CROCERA COMPL.4-60 C/INGR.	SPIDER COMPL. 4-60
1573	INGRASSATORE M8X1.25 2802	GREASE FITTING M8X1.25 2802
1707	VITE TSEI 8X30 5933 Z.B. 10.9	SCREW TSEI 8x30 5933 ZINC P.
1812	COMPLESSIVO DISCO PULEGGI Ø600	PULLEY DISC ASSEMBLY D.600
10111	VITE BLOC.BRAC.P.PALE 4-60	SCREW LOCK TOOLHOLDER 4-60
4105	DISCO FRATT.D.600 4 LING.	TROWEL DISC D.600 4 KEY
4201	PACCO PALETTE 4-60 IN POLLICI	TOOL HOLDER PACKAGE MOSKITO 4-60 INCHES
8970	VITE TE UNC 1/4" x 1" 1/2 (TE 6X35)	SCREW HEX HEAD UNC 1/4" x 1" 1/2 ZINC P.

This page was left blank intentionally

No part of this publication may be reproduced, stored in a backup system or transmitted to third parties in any form or by any means, without a written authorization by the Manufacturer.